



# 迫緊接頭

## ①適用⇒

軟管如: PU·PVC·PE·Silicone, Rubbers 等。  
硬管如: NYLON·PP·TEFLON 銅 鋼 鋁 玻璃等。

## ②壓力⇒ 50 psi & 220 psi max.

## ③採用⇒ 符合 USDA·FDA·N.S.F. 材質要求。

## ◎迫緊式接頭使用方法

1. 截取適當長度的管材，並除去內外管壁的毛邊。
2. 將管子穿過固定螺帽 (Ferrule Nut)，並插入接頭內，會碰到管壁內凸緣 (Tube Stop)。
3. 用手鎖緊固定螺帽後，再用扳手旋緊 1.5 至 2 圈即可。

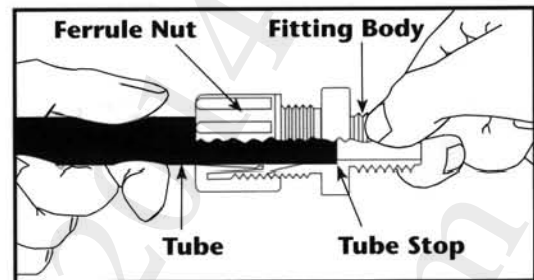

## ◎編號說明 Coding

A 接頭型式 Configurations		B 適用管外徑 Tube O. D.	
A1 ⇒ 單向外牙接頭	L2 ⇒ 內牙彎頭	1 ⇒ 1/8"	4 ⇒ 1/2"
CC ⇒ 雙向接頭/異徑接頭	LC ⇒ 彎頭	2 ⇒ 1/4"	5 ⇒ 5/8"
PM ⇒ 隔板固定接頭	T1 ⇒ 外牙三通	0 ⇒ 5/16"	6 ⇒ 3/4"
A2 ⇒ 單向內牙接頭	TC ⇒ 三通	3 ⇒ 3/8"	7 ⇒ 7/8"
L1 ⇒ 外牙彎頭	T2 ⇒ 外牙分流三通		

C 管牙 NPT Thread	D 材質代碼	E 固定螺帽 Nuts
1 ⇒ 1/8"	Materials Code	50 ⇒ 耐壓 50p.s.i.，適用各種管子附一體成型管套。
2 ⇒ 1/4"	K ⇒ Kynar (PVDF)*	2P ⇒ 耐壓 220p.s.i.，適用各種塑膠硬管，兩件式附塑膠管套。
3 ⇒ 3/8"	N ⇒ Nylon	2S ⇒ 耐壓 220p.s.i.，適用各種硬管兩件式附不銹鋼管套。
4 ⇒ 1/2"	P ⇒ P.P.	
6 ⇒ 3/4"	C ⇒ Cetal (Acetal)**	

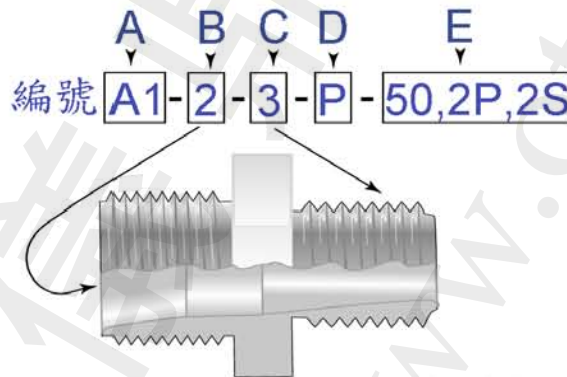

\*Hochest Celance Corp. 註冊商標

\*\*Atochem North America, Inc. 註冊商標

編號 Part No.	管外徑 Tube O. D.	外牙 NPT	編號 Part No.	管外徑 Tube O. D.	外牙 NPT	單向外牙接頭 Male Connectors
A1-1-1	1/8"	1/8"	A1-4-1	1/2"	1/8"	
A1-2-1	1/4"	1/8"	A1-4-2	1/2"	1/4"	
A1-2-2	1/4"	1/4"	A1-4-3	1/2"	3/8"	
A1-2-3	1/4"	3/8"	A1-4-4	1/2"	1/2"	
A1-0-1	5/16"	1/8"	A1-5-3	5/8"	3/8"	
A1-0-2	5/16"	1/4"	A1-5-4	5/8"	1/2"	
A1-3-1	3/8"	1/8"	A1-6-4	3/4"	1/2"	
A1-3-2	3/8"	1/4"	A1-6-6	3/4"	3/4"	
A1-3-3	3/8"	3/8"	A1-7-6	7/8"	3/4"	
A1-3-4	3/8"	1/2"				

編號 Part No.	管外徑 Tube O. D.	雙向接頭		雙向異徑接頭	編號 Part No.	管外徑 Tube O. D.
CC-2	1/4" x 1/4"				CC2-1	1/4" x 1/8"
CC-0	5/16" x 5/16"	CC0-2	5/16" x 1/4"			
CC-3	3/8" x 3/8"	CC3-2	3/8" x 1/4"			
CC-4	1/2" x 1/2"	CC4-3	1/2" x 3/8"			
CC-5	5/8" x 5/8"	CC5-3	5/8" x 3/8"			
CC-6	3/4" x 3/4"	CC5-4	5/8" x 1/2"			
CC-7	7/8" x 7/8"	CC7-5	7/8" x 5/8"			

編號 Part No.	管外徑 Tube O. D.	隔板固定雙向接頭 Bulkhead Unions	
PM-2	1/4"		
PM-0	5/16"		
PM-3	3/8"		
PM-4	1/2"		
PM-6	3/4"		

編號 Part No.	管外徑 Tube O. D.	內牙 NPT	編號 Part No.	管外徑 Tube O. D.	內牙 NPT	單向內牙接頭 Female Connectors
A2-2-1	1/4"	1/8"	A2-3-4	3/8"	1/2"	
A2-2-2	1/4"	1/4"	A2-4-3	1/2"	3/8"	
A2-0-2	5/16"	1/4"	A2-4-4	1/2"	1/2"	
A2-3-2	3/8"	1/4"	A2-5-4	5/8"	1/2"	
A2-3-3	3/8"	3/8"				

編號 Part No.	管外徑 Tube O. D.	外牙 NPT	編號 Part No.	管外徑 Tube O. D.	外牙 NPT	L 型外牙彎頭 Male Elbows
L1-1-1	1/8"	1/8"	L1-3-3	3/8"	3/8"	
L1-2-1	1/4"	1/8"	L1-4-2	1/2"	1/4"	
L1-2-2	1/4"	1/4"	L1-4-3	1/2"	3/8"	
L1-2-3	1/4"	3/8"	L1-4-4	1/2"	1/2"	
L1-0-1	5/16"	1/8"	L1-5-3	5/8"	3/8"	
L1-0-2	5/16"	1/4"	L1-5-4	5/8"	1/2"	
L1-3-2	3/8"	1/4"				

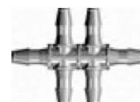

編號 Part No.	管外徑 Tube O. D.	內牙 NPT	編號 Part No.	管外徑 Tube O. D.	內牙 NPT	L 型內牙彎頭 Female Elbows 
L2-1-2	1/8"	1/4"	L2-3-3	3/8"	3/8"	
L2-2-1	1/4"	1/8"	L2-4-3	1/2"	3/8"	
L2-2-2	1/4"	1/4"	L2-4-4	1/2"	1/2"	
L2-0-2	5/16"	1/4"	L2-5-4	5/8"	1/2"	
L2-3-2	3/8"	1/4"				

編號 Part No.	管外徑 Tube O. D.	L 型彎頭 Union Elbows 
LC-2	1/4"	
LC-0	5/16"	
LC-3	3/8"	
LC-4	1/2"	
LC-5	5/8"	
LC-6	3/4"	
LC-7	7/8"	
LC-7-5	7/8" x 5/8"	

編號 Part No.	管外徑 Tube O. D.	外牙 NPT	編號 Part No.	管外徑 Tube O. D.	外牙 NPT	T 型外牙接頭 Male Branch Tees 
T1-2-1	1/4"	1/8"	T1-4-4	1/2"	1/2"	
T1-2-2	1/4"	1/4"	T1-5-4	5/8"	1/2"	
T1-0-2	5/16"	1/4"	T1-6-4	3/4"	1/2"	
T1-3-2	3/8"	1/4"	T1-6-6	3/4"	3/4"	
T1-3-3	3/8"	3/8"	T1-7-6	7/8"	3/4"	
T1-4-3	1/2"	3/8"				

編號 Part No.	管外徑 Tube O. D.	編號 Part No.	管外徑 Tube O. D.	T 型接頭 Union Tees 
TC-1	1/8"	TC-5-3	5/8" x 3/8"(中間)	
TC-2	1/4"	TC-6	3/4"	
TC-0	5/16"	TC-7	7/8"	
TC-3	3/8"	TC-7-5	7/8" x 5/8"(C中)	
TC-4	1/2"	TC-7-5-5	7/8" x 5/8" x 5/8" 右(R)x(C中)x左(L)	
TC-5	5/8"			

編號 Part No.	管外徑 Tube O. D.	外牙 NPT	編號 Part No.	管外徑 Tube O. D.	外牙 NPT	T 型外牙分流接頭 Male Run Tees 
T2-2-1	1/4"	1/8"	T2-4-4	1/2"	1/2"	
T2-2-2	1/4"	1/4"	T2-5-4	5/8"	1/2"	
T2-0-2	5/16"	1/4"	T2-6-4	3/4"	1/2"	
T2-3-2	3/8"	1/4"	T2-6-6	3/4"	3/4"	
T2-3-3	3/8"	3/8"	T2-7-6	7/8"	3/4"	
T2-4-3	1/2"	3/8"				